

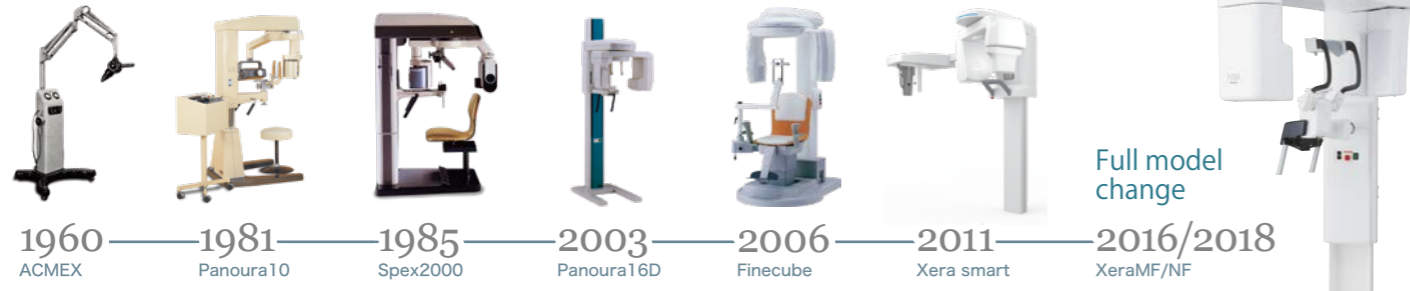

Six Decades of Diagnostic Imaging Innovation

Since the release of our ACMEX X-ray imaging equipment in 1960, Yoshida has continued to develop and manufacture cutting-edge imaging technologies trusted by doctors around the world.



Dimensions

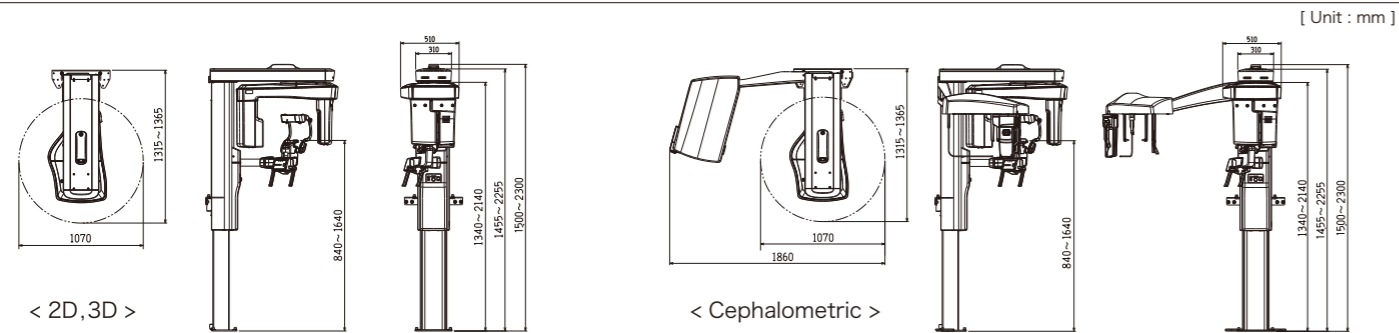

Technical data

Panoramic

- Sensor Direct CMOS Sensor
- Grading 16 bit (65,536 grading)
- Exposure time 7, 12 sec. (Panoramic)
..... 3.4 sec. x 2 (TMJ)
- Magnification factor.. 1.3 - 1.4 (Panoramic exposure, TMJ exposure)
- Pixel 100 μm isotropic / pixel
..... 1,510 x 3,341 pixel (Panoramic)*

*Horizontal pixel may change by the adjustment of layer.

Cephalometric

- Sensor Direct CMOS Sensor
- Exposure time 8 sec. / 12 sec. (PA),
..... 10 sec. / 15 sec. (LA),
..... 8 sec. / 12 sec. (Carpus)
- Magnification factor.. 1.1
- Pixel 2605 pixel x 2266 pixel (LA)
..... 2097 pixel x 2266 pixel (PA / Carpus)

3D

- Sensor CMOS Sensor
- FOV size
- Xera MF φ 44mm x H64mm (61mm) 90μm
φ 80mm x H79mm (72mm) 150μm
φ 110mm x H79mm (69mm) 180μm
φ 156mm x H79mm (65mm) 230μm
- Xera NF φ 44mm x H64mm (61mm) 90μm
φ 85mm x H64mm (58mm) 150μm
- Voxel size
- Exposure time
Standard.. 12 sec. (same for all FOV size)
High def... 16 - 20 sec.
(Varies depending on the FOV size)

Common spec.

- Tube voltage..... 70 - 90 kV
- Tube current 2.0 - 4.0 mA
- Power supply AC 100 - 120V ±10%,
..... AC 220 - 240V ±10%
- Total filtration..... 2.5 mm Aluminum equivalent or higher
- Operating condition
Temperature..... 10 to 40°C (50 to 104°F)
Relative humidity..... 30 to 75 % (no condensation)
Atmospheric pressure..... 700 to 1060 hPa
- To install, the equipment needs to be wall-mounted.

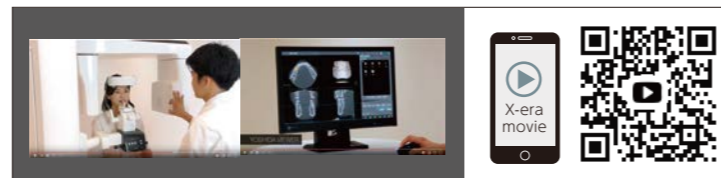

The product specifications vary depending on the area of purchase. Please contact your local distributor for further information.



© THE YOSHIDA DENTAL MFG. CO., LTD.

Distributor

YOSHIDA

THE YOSHIDA DENTAL MFG. CO., LTD.
Address 1-3-6 Kotobashi, Sumida-ku Tokyo, Japan ZIP 130-8516
TEL +81-3-3631-2165 FAX +81-3-3631-2685 (International Business Div.)



www.facebook.com/
YoshidaDentalManufacturing



www.yoshida-net.co.jp/en

First Edition

YOSHIDA



*Clearer imaging.
Clearer decisions.*

X-ERA

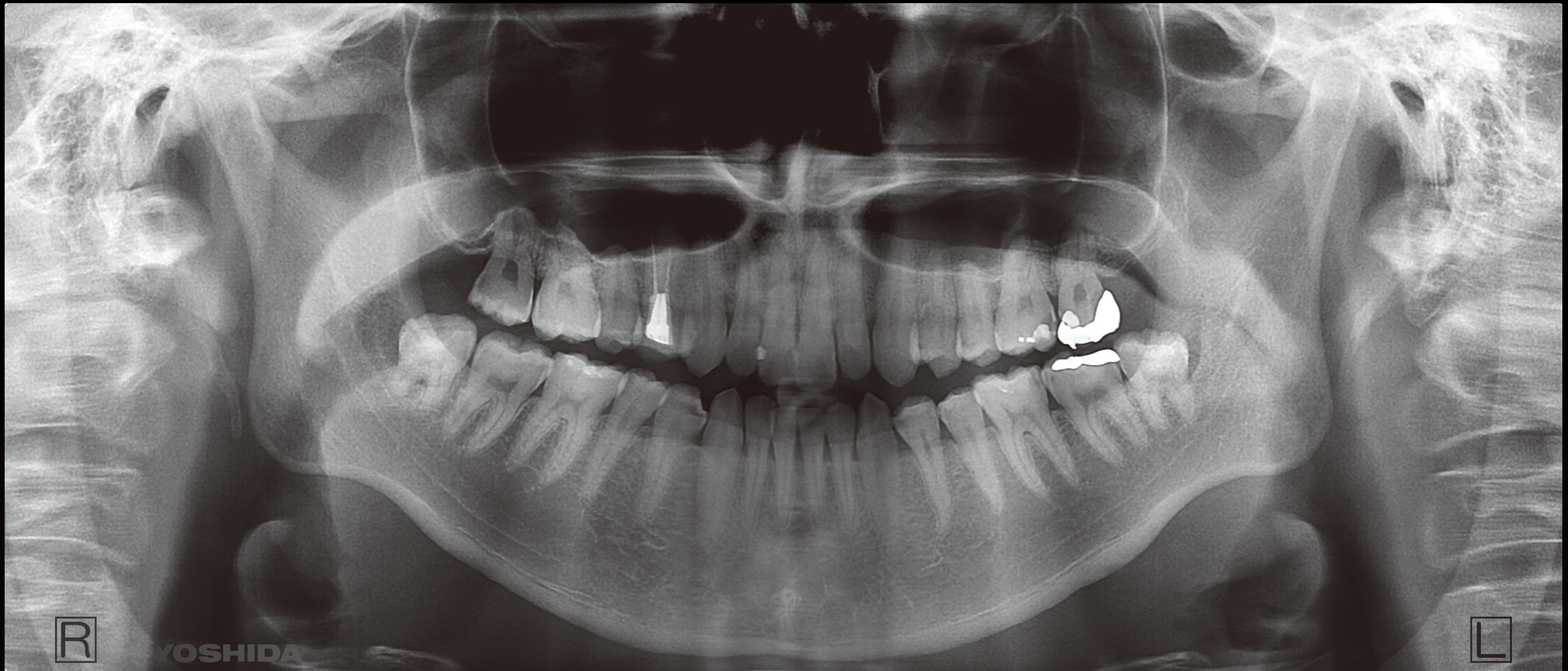

2D

Superior image quality for a confident diagnosis

X-era produces a crisp, high-quality image with uncompromised clarity, revealing a finer level of detail on every capture. It reduces the need for retakes and minimizes the time spent on post-capture image enhancement.

High-definition clinical image quality for an accurate diagnosis

X-era is designed with a direct CMOS sensor and unique image construction technology, enabling it to produce a sharper image.

Combines the finest details of more than 3,600 single high resolution images to provide a sharp and high-definition scan. (16 bit 65,536 grading)

Captures the finest details from more than 3,600 high-resolution images

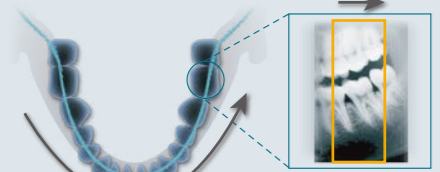

*Image is for illustration purposes only

Indirect conversion vs. Direct conversion

*The diagram below is for illustration purposes only

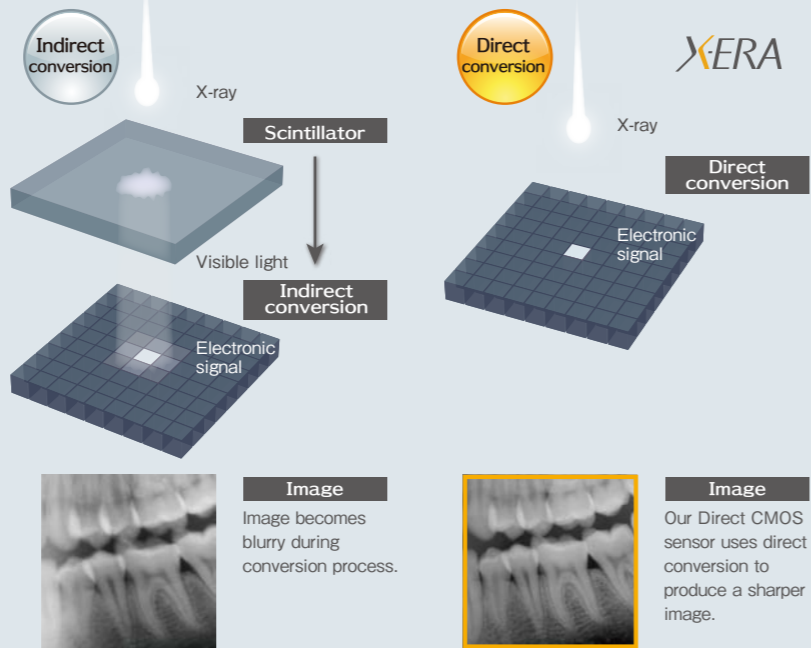

Multi-layer dental clipping



You can even transfer a single clipped image to your viewer software.

18-image method is also available.

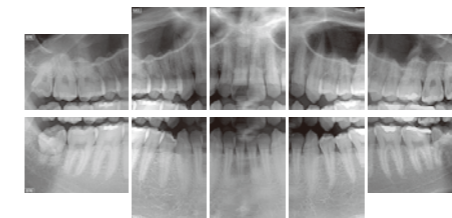

10-image method

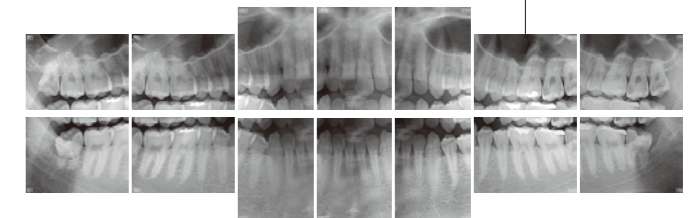

14-image method

Multi Focal Layer Technology zeroes in on any detail

Pinpoint any area to gain a clear view for your diagnosis. Even after capturing the images, you can reconstruct them to match the patient's dentition size and shape, thus reducing the risk of retake.

< Incorrect positioning >

< Autofocus >

Easily correct positioning errors

< Position >

Radiographic failure caused by incorrect patient positioning can be corrected easily by the unique adjustment feature, even after the exposure, resulting in a nearly flawless panoramic image.

Select dentition size and shape

< Arch size > < Arch shape >

Easily adjust images to the optimal size and shape of the focal layer, even after the X-rays have been taken.

Cephalometric sensor options

Cephalometric (Type 1)
Manually adjust sensor for Cephalometric or Panoramic scans
Cost efficiency

Cephalometric (Type 2)
Use the software to effortlessly switch between fixed Cephalometric and Panoramic sensors
Preferred Functionality



2D exposure modes

Cephalometric exposure mode



Panoramic exposure mode

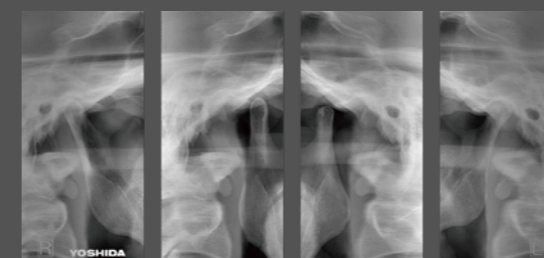

< TMJ 2 views > *Images above reflect TMJ4 views.



3D

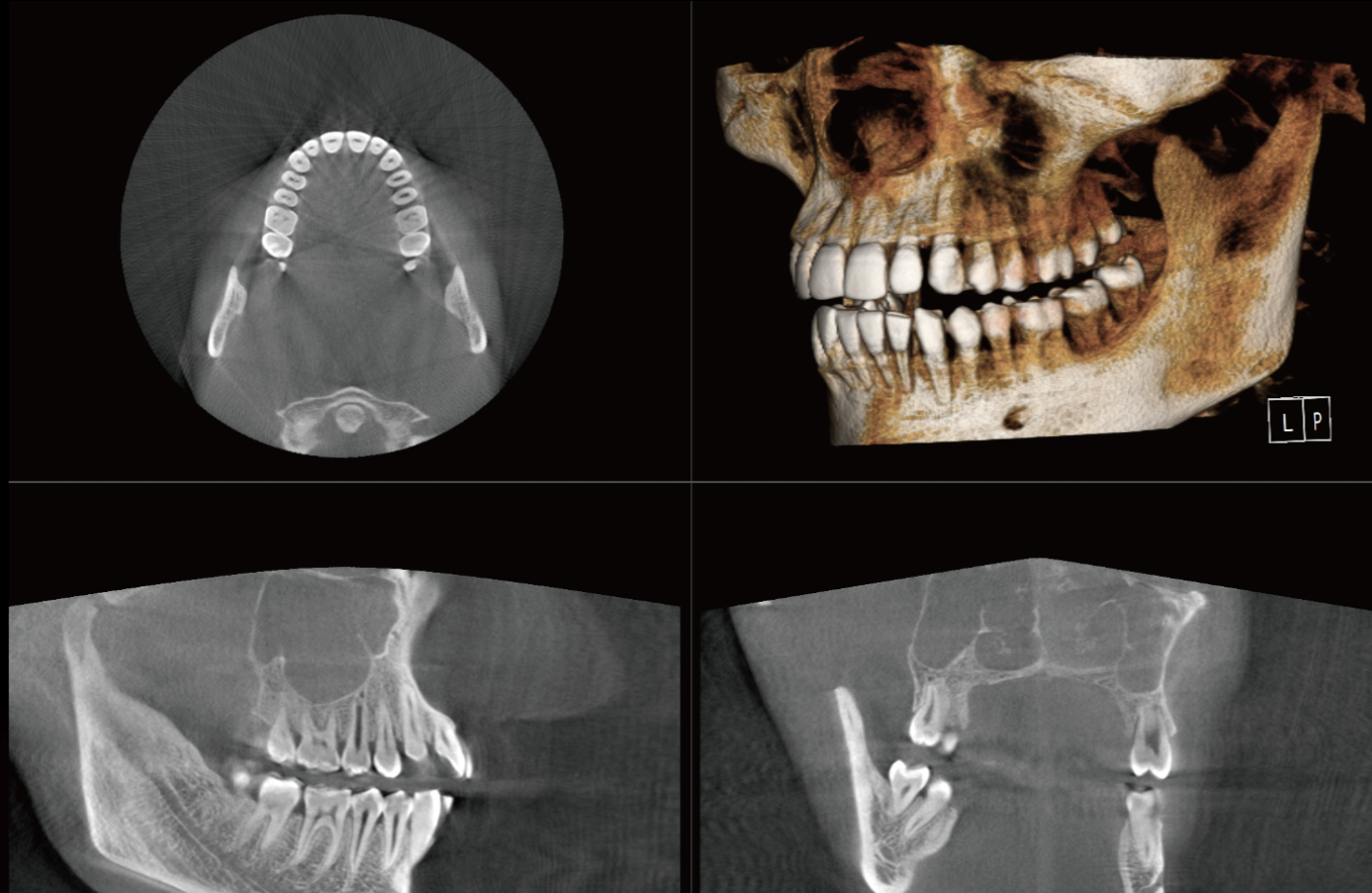

Exceptionally sharp 3D imaging to meet the needs of every doctor

X-era provides fast 3D scanning with brilliant results. It captures pristine, high-definition 3D images to accommodate a comprehensive range of clinical needs. In addition, we've shortened the scan time, reducing the burden on patients and making it easier for you to incorporate 3D imaging into daily practice.

High-definition 2D/3D image with high focus

With a focal size of only 0.2 mm, X-era produces higher-definition images with less blurring, making your diagnoses even easier.

0.2_{mm}
X-ray tube focal spot

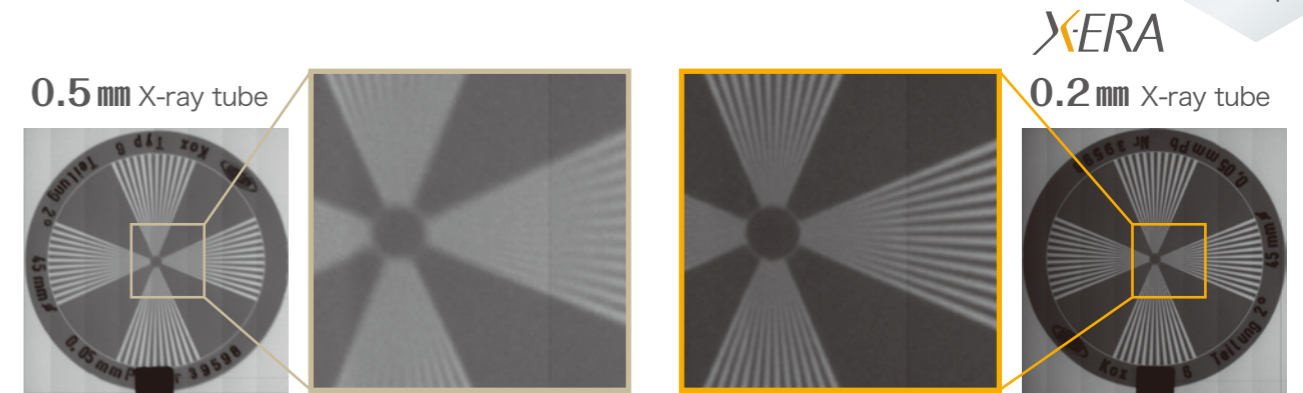

3D exposure modes

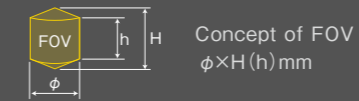

			X-ERA NF	X-ERA MF
Endodontic, Impacted tooth extraction	 64 _{mm} (61 _{mm}) φ 44 _{mm}	 64 _{mm} (61 _{mm}) φ 44 _{mm}	<input type="checkbox"/>	<input type="checkbox"/>
Perio Implant	 64 _{mm} (58 _{mm}) φ 85 _{mm}	 64 _{mm} (58 _{mm}) φ 85 _{mm}	<input type="checkbox"/>	
Maxillary sinus observation, Implant	 79 _{mm} (72 _{mm}) φ 80 _{mm}	 79 _{mm} (72 _{mm}) φ 80 _{mm}		<input type="checkbox"/>
Impacted tooth observation (both sides), Full mouth implant	 79 _{mm} (69 _{mm}) φ 110 _{mm}	 79 _{mm} (69 _{mm}) φ 110 _{mm}		<input type="checkbox"/>
TMJ full mouth observation, Respiratory tract observation	 79 _{mm} (65 _{mm}) φ 156 _{mm}	 79 _{mm} (65 _{mm}) φ 156 _{mm}		<input type="checkbox"/>

Clinical Examples

Multiple scan modes accommodate a wide range of clinical needs. The examples below illustrate how each mode can bring clarity to common clinical conditions.



Buccolingual view Mesiodistal view

3D volume view

Endo

A three-dimensional scan allows for a clear diagnosis of a spreading lesion, for example, letting you evaluate it easily from all angles.

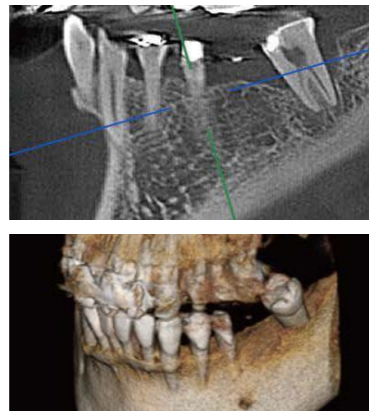
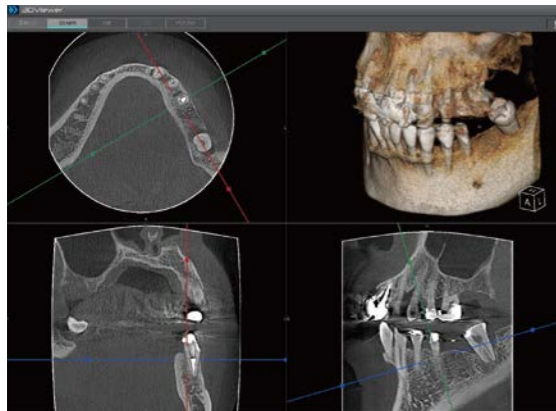

Perio

Three-dimensional examination allows you to make an accurate diagnosis in areas that are difficult to confirm in 2D. In addition, the 3D imaging gives patients a clearer picture of their diagnosis, making it easier for them to understand, which also benefits the process of obtaining informed consent.



EXT

<Horizontally Impacted Wisdom Tooth>

With X-era's 3D imaging, you can easily discern the positional relation between the mandibular canal and the root apex, helping you determine the best approach for surgery.

Design Philosophy

X-era has been carefully designed to benefit both doctors and patients. Regardless of the scanning area or diagnosis, capturing images is quick, easy and comfortable, thanks to exclusive design features developed by YOSHIDA. These features help to reduce the burden on both doctor and patient.

Face-to-face positioning

The arm is designed with a 55-degree angle so it is optimized for patient entry and positioning *1. A patient in a wheelchair can also comfortably be accommodated *2. Switch easily between Panoramic and 3D exposure by simply changing the bite blocks.

*1 : Based on YOSHIDA research.

*2 : Consult your local YOSHIDA dealer for wheelchair accessible installation.



Easy patient positioning

Compact design fits in smaller X-ray rooms.

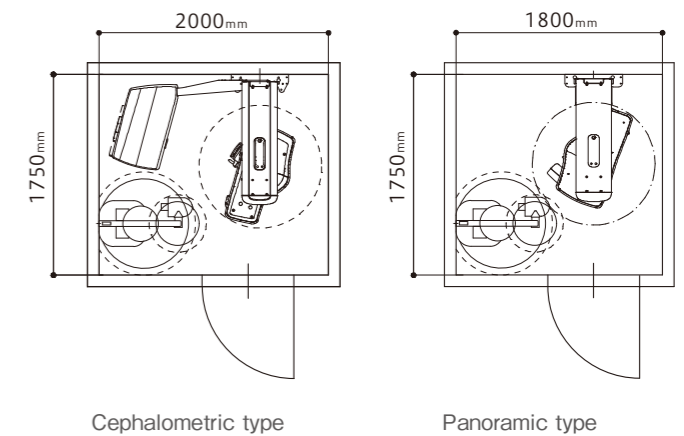

Cephalometric type

Panoramic type

360° CT scan in just 12 seconds—with our largest FOV

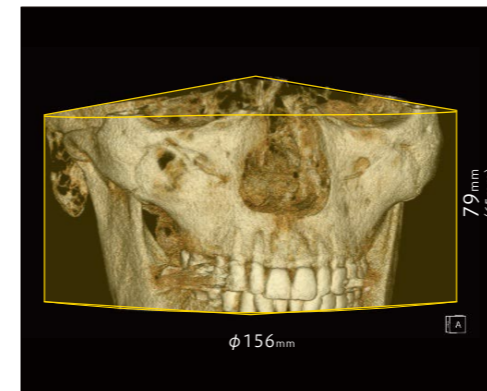

Even with X-era's largest FOV size (φ156 mm × 79 mm), a full 360-degree 3D scan takes as little as 12 seconds. High-speed scans reduce the risk of patient movement, thus minimizing motion artifacts in the image.

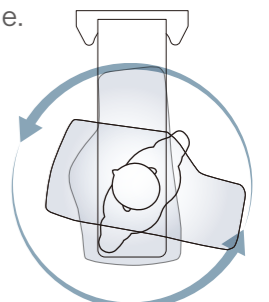

VIEWER



In-house software ONESYSTEM

Our imaging software is intuitive and easy to use. It's designed with a wide range of practical functions for your daily practice, from scanning to patient consultations.

Scan



Select scan mode using the quick and intuitive interface

View

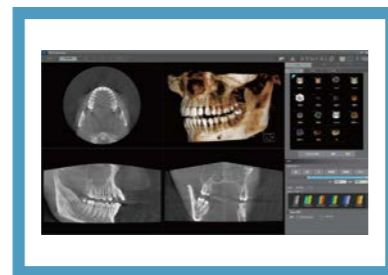

View and manipulate various types of images with just a few clicks

Edit



Customize the look of your images without hassle or confusion

2DViewer



You can view panoramic and imported images, such as intraoral and camera images, on one screen. The interface makes it easy to magnify or compare images as needed.

3DViewer

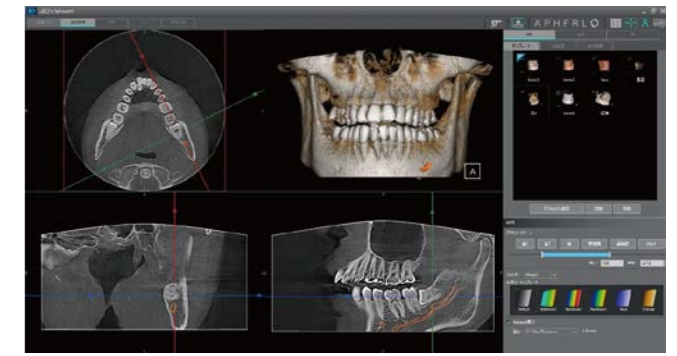

With the click of a mouse, you can easily evaluate the 3D images from all angles, gathering the information you need to make an accurate diagnosis.

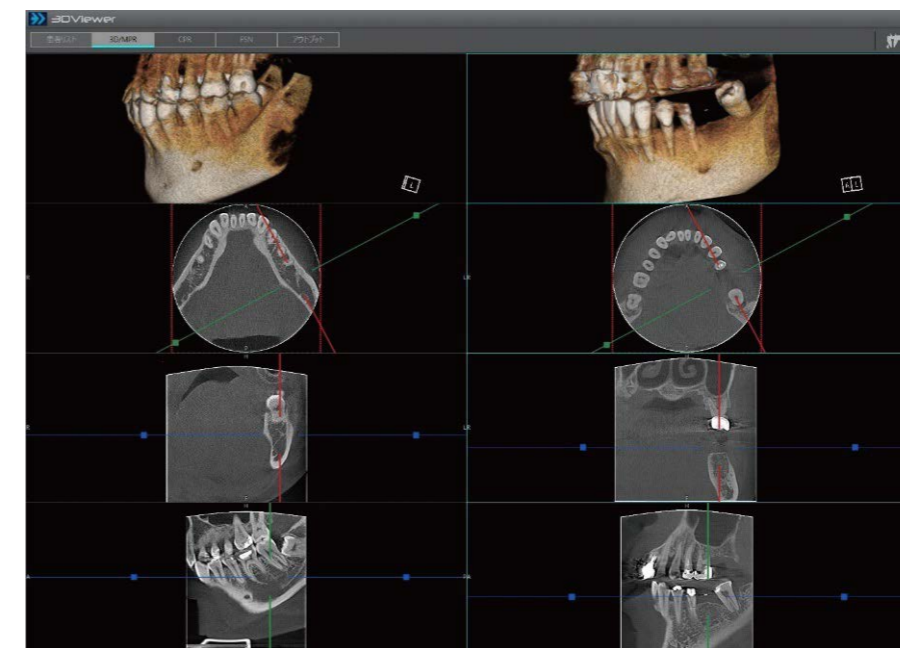

Multiview

Quickly compare pre- and post-operative images on one screen to give patients a clear picture of their treatment progress.

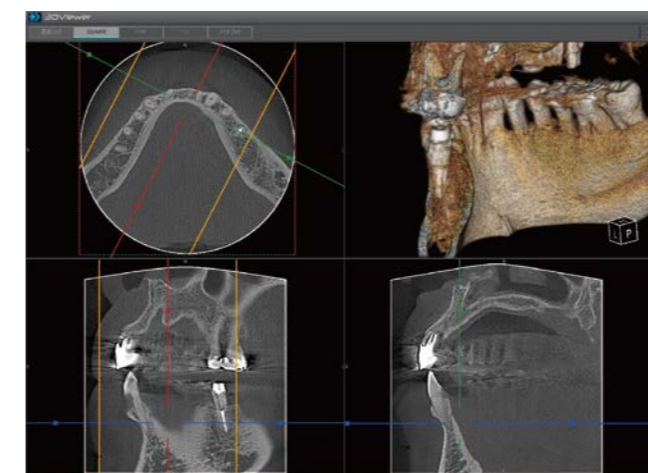

3D image cutting feature

3D volume images can be cut to view a sliced plane. This is useful in a variety of diagnoses: for example, when determining the buccolingual shape of the defective part or when checking the cross section of the tooth axis.



3D movie

Easily generate a 3D animation of your images to use as presentation material or for transferring data to doctors or patients.